

V51

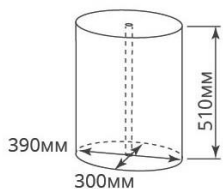

V66

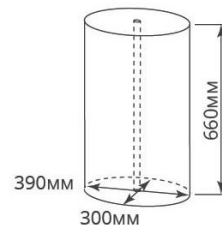

B51

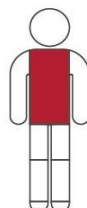
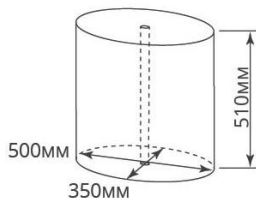

B66

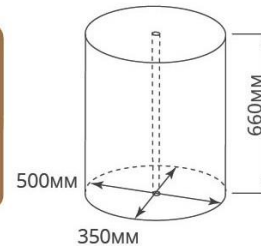

N51

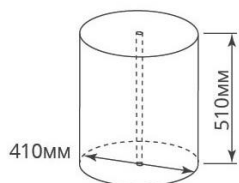

N66

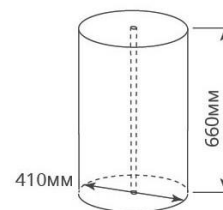

P51

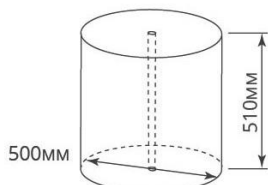

P66

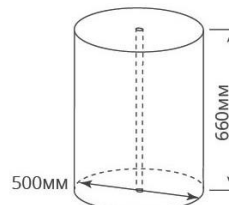

G51

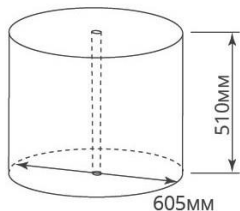

G70

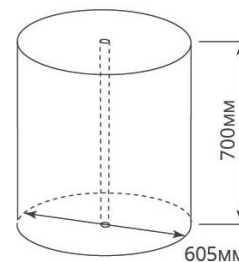

G90

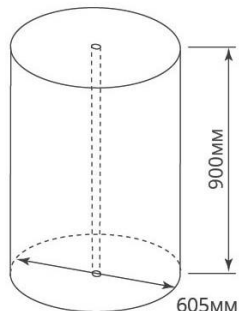

V110

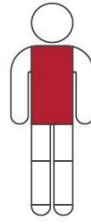
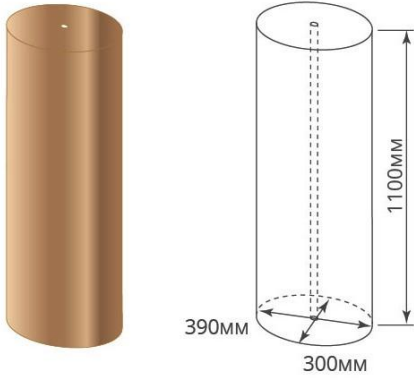

OI 39-110

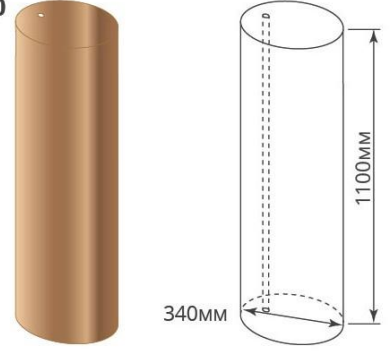

P1

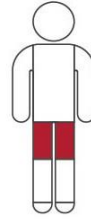
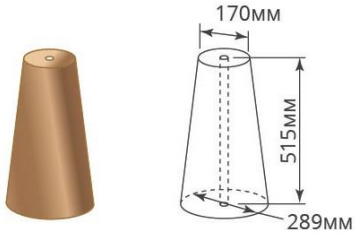

P1B



P2

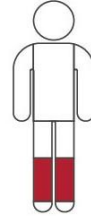
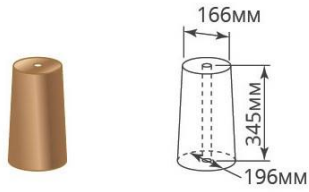

P2B



OI59

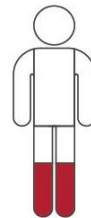
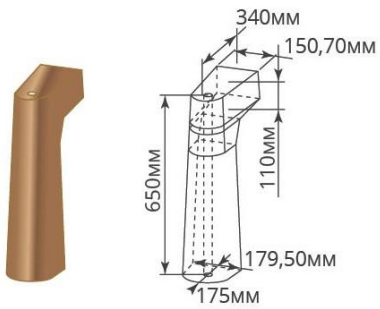

OI59B

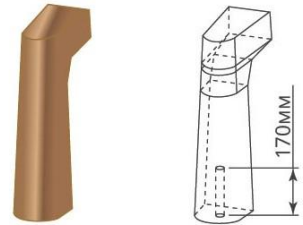

AFO2

